

Part number:

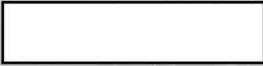

**HYDROMA**

HYDRAULICKÉ SYSTÉMY

**HIDROMA  
SYSTEMS**

UKŁADY HYDRAULICZNE

**HYDROMA**

ГИДРАВЛИЧЕСКИЕ СИСТЕМЫ

Solenoid operated valves pilot operated poppet type  
2-way normally closed  
Special cavity, 017-E

VEI-16-NC

OD.15 - X - 17 - Y - Z

**RE 18323-34**

Edition: 04.2021

Replaces: 03.2020

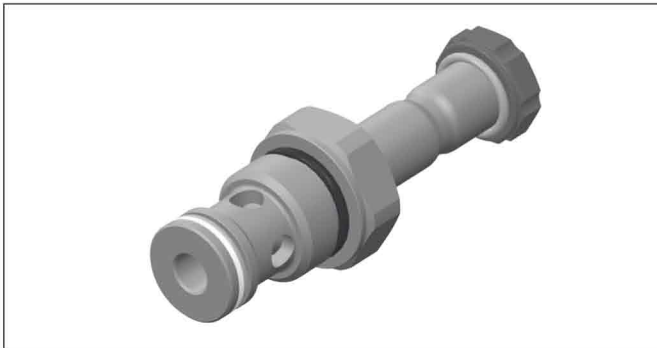

PATENT PENDING

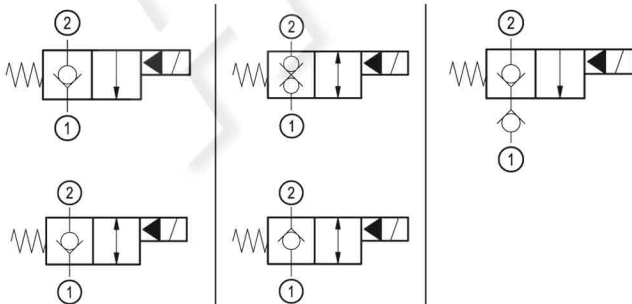
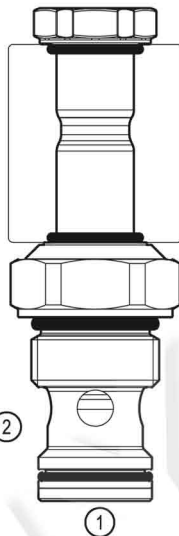

**Technical data**

New VEI-16 family incorporates a new solenoid concept providing excellent performance and enables cartridges to work in severe environment. Cartridges also incorporates advanced design of hydraulic parts providing excellent hydraulic performance.

**Technical data**

General	
Weight	0.25 kg (0.55 lbs)
Installation orientation	Unrestricted
Storage ambient temperature range	-40 to 100 °C (-40 to 212 °F)
Operating ambient temperature range	-30 to 90 °C (-22 to 194 °F)
Salt spray test to DIN EN ISO 9227:2017-07	500h
Hydraulic	
Max. operating pressure	350 bar (5000 psi)
Flow range	2 - 70 l/min (0.53 - 18 gpm)
Fatigue cycle life	2 million cycles at 350 bar
Max. internal leakage	5 drops/min. for X=01,05,11 20 drops/min. for X=03,31
Installation torque	54 - 66 Nm (40 - 49 ft-lbs)
Switching time	Opening ≤ 50 ms Closing ≤ 100 ms
Fluid temperature range	-20 to 80 °C (-4 to 176 °F)
Fluids: Mineral-based or synthetics with lubricating properties at viscosities of 20 to 380 mm <sup>2</sup> /s (cSt)	
Recommended degree of fluid contamination	Nominal value max. 10 µm (NAS 8) ISO 4406 19/17/14
MTTFD	150 years see RE 18350-51
Special cavity	017-E see 18325-75
Seal kit for X=01,05,11	code material no. RG17E201052010 R934003562
Seal kit for X=03,31	code material no. RG17E201053010 R934003563
Seal kit coil and standard cap	code material no. RG02Z0010000100 R930067869
Seal kit coil and protective cap only for Y=D	code material no. RG03Z0010000100 R930067870
Other technical data	See data sheet 18350-50
Electrical	
Type of voltage	DC voltage
Coil type	D36
Supply voltage	See data sheet 18325-90
Voltage tolerance against ambient temperature	See characteristic curve
Power consumption	20 W
Type of protection	See data sheet 18325-90
Note: Coils must be ordered separately	

Ordering code

<b>OD.15</b>	<b>X</b>	<b>17</b>	<b>Y</b>	<b>Z</b>	<b>0000</b>	<b>*</b>
--------------	----------	-----------	----------	----------	-------------	----------

Solenoid operated valves  
pilot operated poppet type  
2-way normally closed

---

monodirectional type

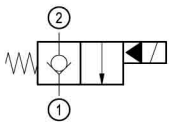

**01**

---

bidirectional type

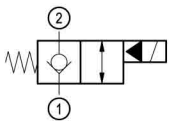

**05**

---

monodirectional type with check

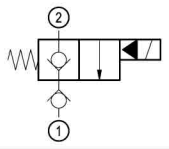

**11**

---

bidirectional type

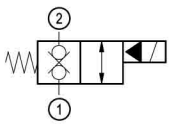

**31**

---

bidirectional type

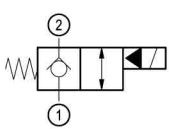

**03**

Series O/A to L  
unchanged performances and dimensions

0 = With buna seal  
8 = With buna seal and extra spring only for **03, 05, 31**  
V = With Viton seal  
P = With buna seal and protective cap for override version **D**  
T = With Viton seal and protective cap for override version **D**

A = Standard  
D = Knob style manual override  
E = Pull style manual override  
F = Hand operated pull style manual override

Special cavity: 017-E

Preferred types

Type	Material number
OD150117A000000	R930062337
OD150117D000000	R930065472
OD150517A000000	R930062338
OD150517D000000	R930064099
OD151117A000000	R930064362
OD150517DP00000	R930066439
OD153117A000000	R930065028
OD153117D000000	R930067162

Type	Material number
OD150317A000000	R930066965
OD150317D000000	R930066967
OD150517A800000	R930065551
OD150317A800000	R930065610
OD150517E000000	R930070202
OD153117A800000	R930066700
OD153117D800000	R930067588

Characteristic curves

All Versions - Admissible supply voltage Vs. Ambient temperature at 100% duty cycle

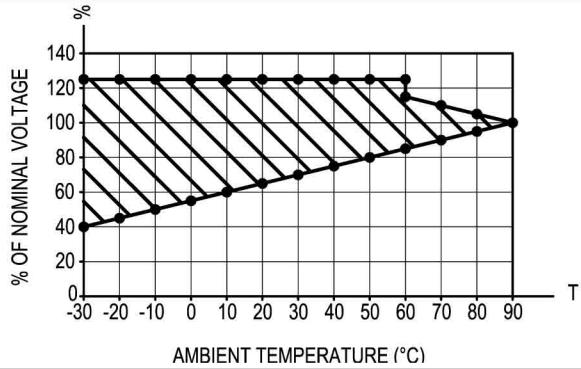

Versions 01, 05      Versions 03, 05 with extra spring

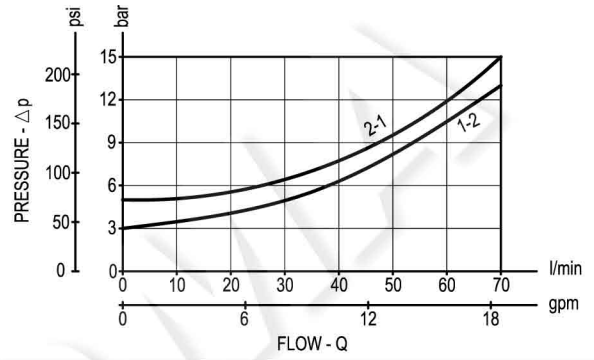
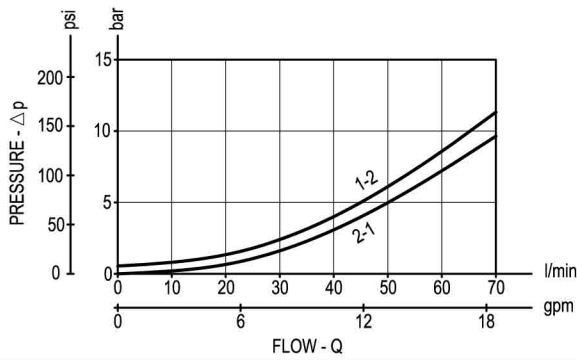

Version 11      Version 03

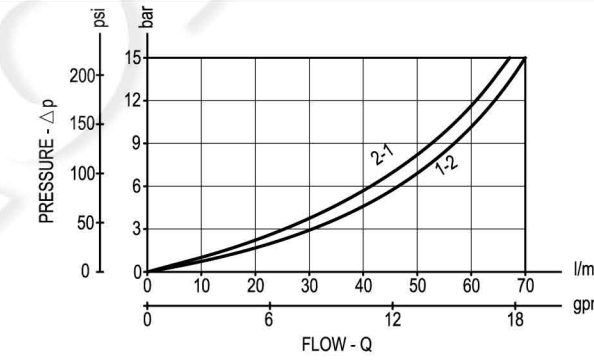
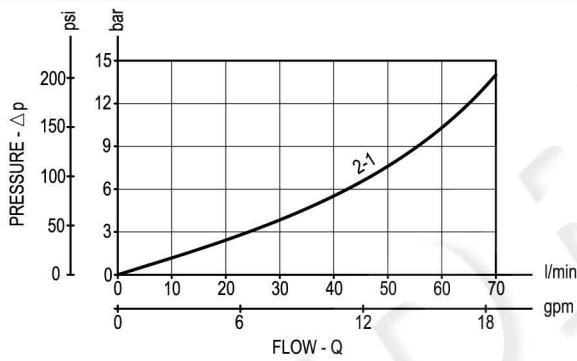

Version 31      Version 31 with extra spring

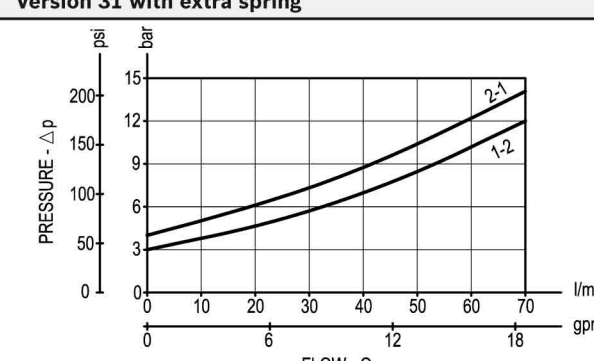
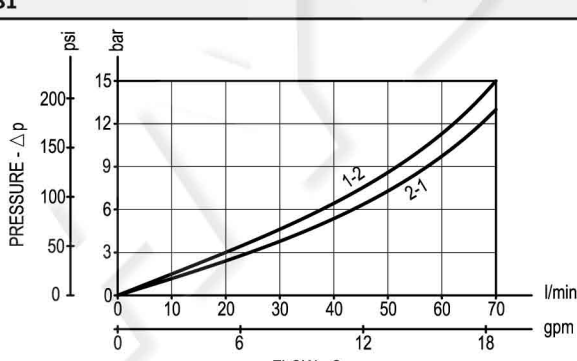

**Dimensions**

**Solenoid operated valves pilot operated poppet type  
2-way normally closed**

Hand operated Pull style manual override

