

Part number:

HYDROMA

HYDRAULICKÉ SYSTÉMY

**HIDROMA
SYSTEMS**

UKŁADY HYDRAULICZNE

HYDROMA

ГИДРАВЛИЧЕСКИЕ СИСТЕМЫ

Technická data hliníkových motorů IE3

	Type	Power		Speed r/min	Amps 400V	frequency Hz	EFF. %	P.F. cosφ	Rated Torque Nm	LRT RLT	BDT RLT	LRA RLA
		kW	HP									
	3A132S2-2	7,5	10	2940	13,70	50	90,1	0,88	24,36	2,0	2,3	7,9
	3A160M1-2	11	15	2950	19,60	50	91,2	0,89	35,61	2,0	2,3	8,1
	3A160M2-2	15	20	2950	26,50	50	91,9	0,89	48,56	2,0	2,3	8,1
	3A160L-2	18,5	25	2950	32,50	50	92,4	0,89	59,89	2,0	2,3	8,2
	3A132M-4	7,5	10	1470	14,30	50	90,4	0,84	48,72	2	2,3	7,5
	3A160M-4	11	15	1470	20,40	50	91,4	0,85	71,46	2,2	2,3	7,7
	3A160L-4	15	20	1470	27,30	50	92,1	0,86	97,45	2,2	2,3	7,8
	3A160M-6	7,5	10	980	15,40	50	89,1	0,79	73,09	2,0	2,1	7,00
	3A160L-6	11	15	980	22,00	50	90,3	0,80	107,19	2,0	2,1	7,2

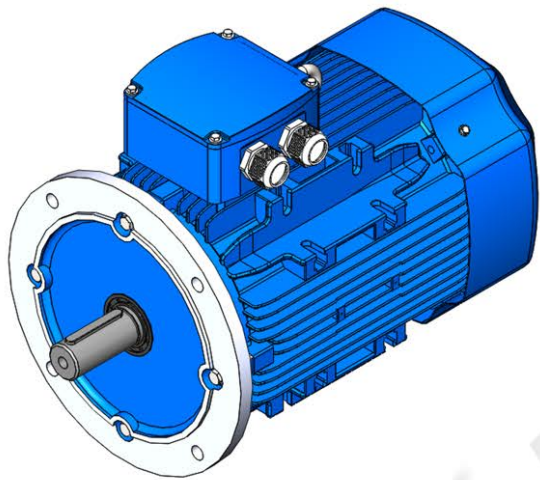
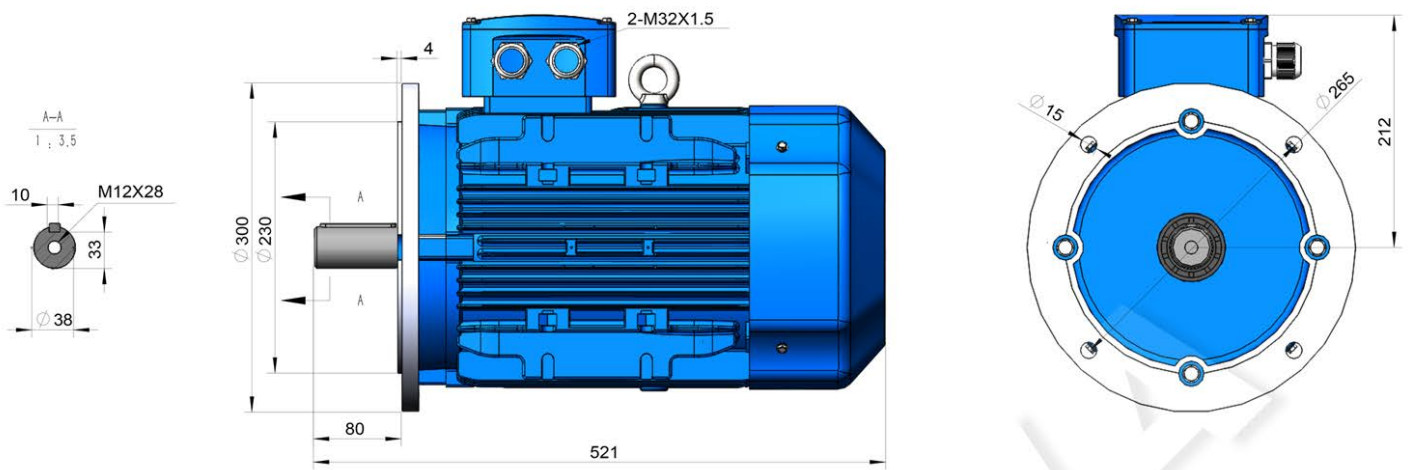

3A132M-B5
Mounting diagram