

Part number:

HYDROMA

HYDRAULICKÉ SYSTÉMY

**HIDROMA
SYSTEMS**

UKLADY HYDRAULICZNE

HYDROMA

ГИДРАВЛИЧЕСКИЕ СИСТЕМЫ



DSA* DIRECTIONAL CONTROL VALVE, PNEUMATICALLY OPERATED

SUBPLATE MOUNTING

DSA3 ISO 4401-03

DSA5 ISO 4401-05

p max (see performances table)

Q nom (see performances table)

OPERATING PRINCIPLE

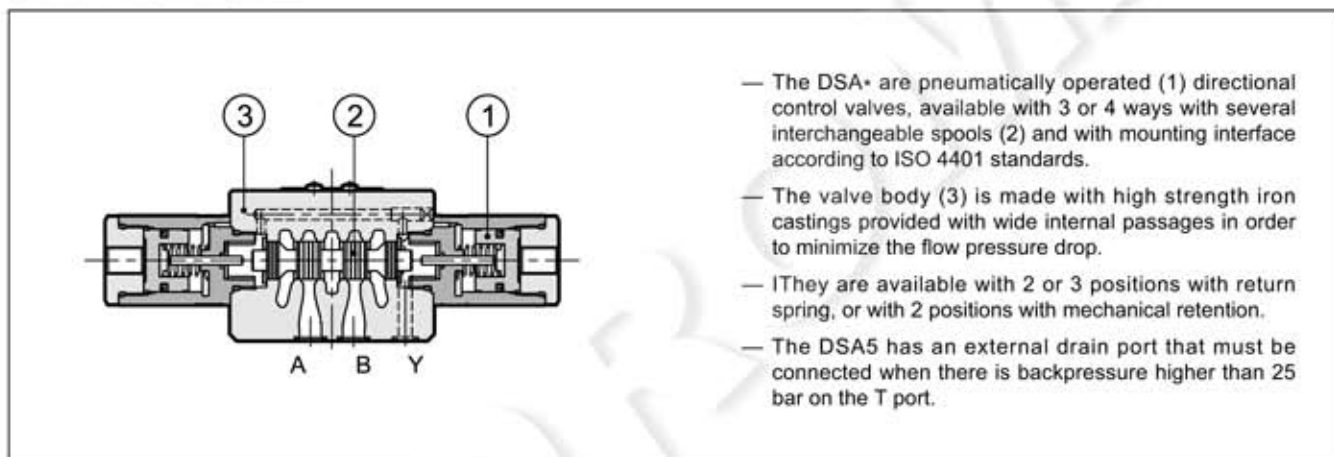

- The DSA* are pneumatically operated (1) directional control valves, available with 3 or 4 ways with several interchangeable spools (2) and with mounting interface according to ISO 4401 standards.
- The valve body (3) is made with high strength iron castings provided with wide internal passages in order to minimize the flow pressure drop.
- They are available with 2 or 3 positions with return spring, or with 2 positions with mechanical retention.
- The DSA5 has an external drain port that must be connected when there is backpressure higher than 25 bar on the T port.

PERFORMANCES

(with mineral oil of viscosity 36 cSt at 50°C)

		DSA3	DSA5
Maximum working pressure:	- P, A, B ports	350	320
	- T port without Y external drain	25	25
	- T port with Y external drain (available for DSA5 only)	-	320
Piloting pressure:	- min	4	4,5
	- max	12	12
Nominal flow rate	l/min	75	120
Ambient temperature range	°C	-20 / +60	
Fluid temperature range	°C	-20 / +80	
Fluid viscosity range	cSt	10 + 400	
Fluid contamination degree		According to ISO 4406:1999 class 20/18/15	
Recommended viscosity	cSt	25	
Mass:	single operator valve	1,3	3,2
	dual operator valve	1,7	4,0

1 - IDENTIFICATION CODE

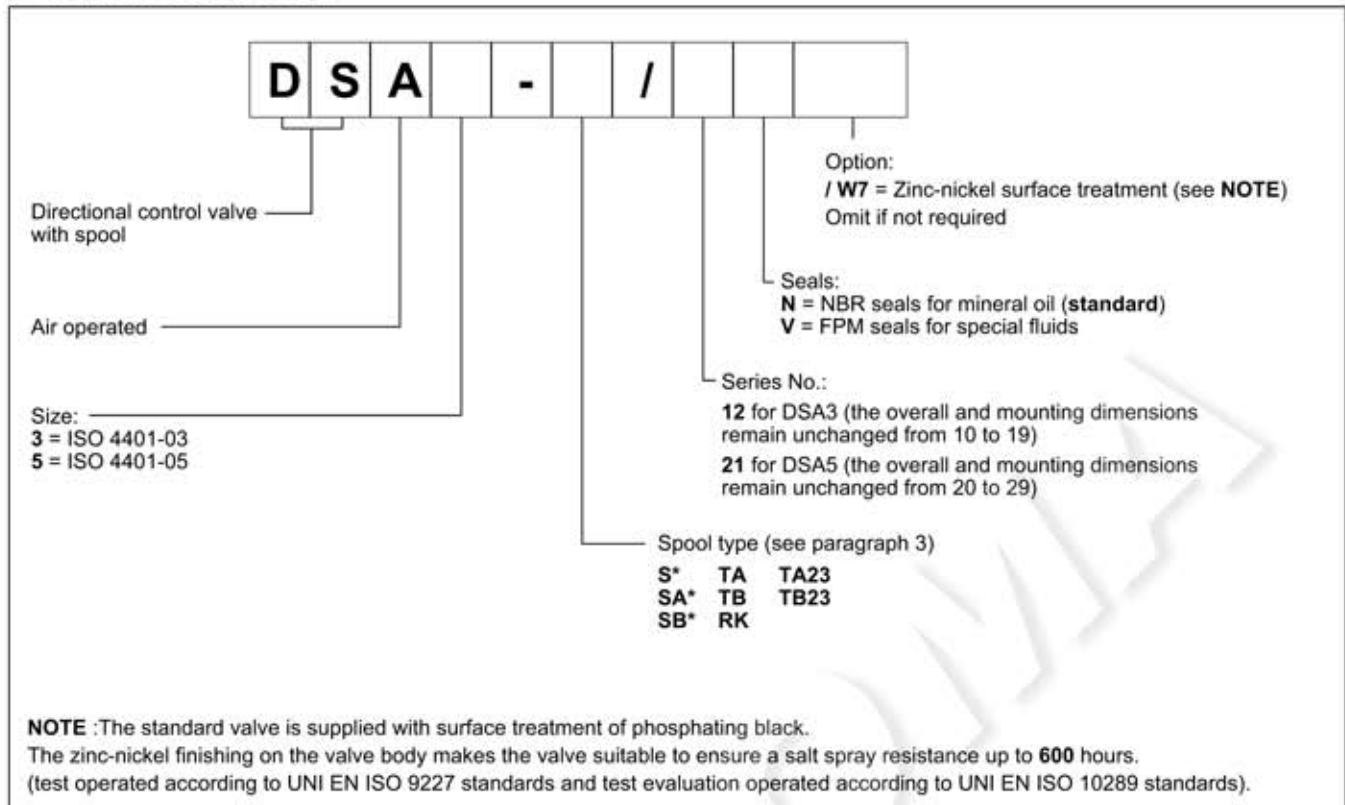

2 - MOUNTING INTERFACES

DSA3

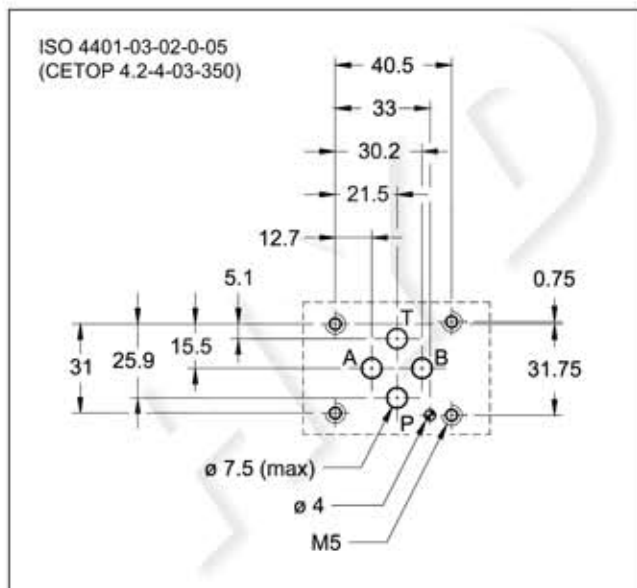

DSA5

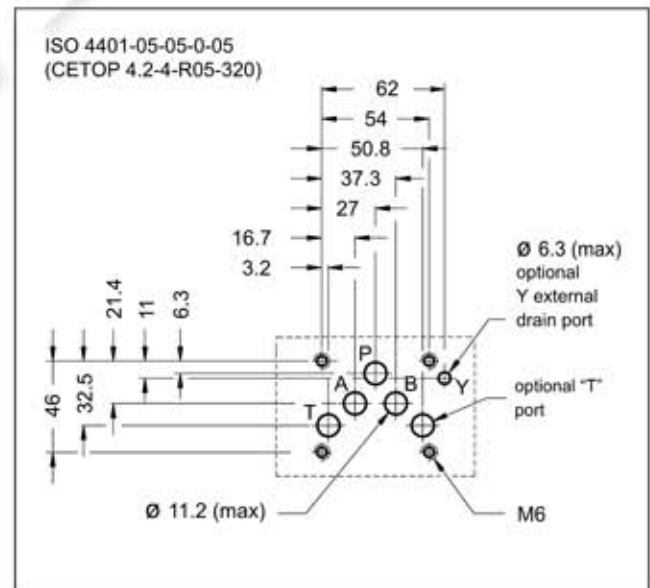

3 - HYDRAULIC FLUIDS

Use mineral oil-based hydraulic fluids HL or HM type, according to ISO 6743-4. For these fluids, use NBR seals (code N). For fluids HFDR type (phosphate esters) use FPM seals (code V). For the use of other fluid types such as HFA, HFB, HFC, please consult our technical department. Using fluids at temperatures higher than 80 °C causes a faster degradation of the fluid and of the seals characteristics. The fluid must be preserved in its physical and chemical characteristics.

4 - SPOOLS TYPES

Type S*:
2 operations - 3 positions
with spring centering

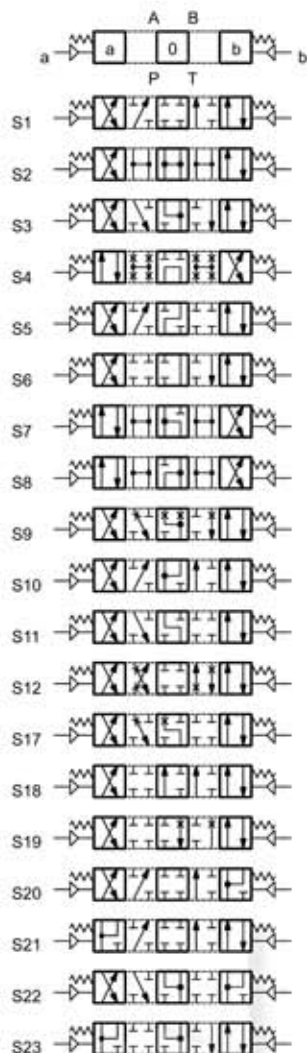

Type SA*:
1 operation side A
2 positions (central + external)
with spring centering

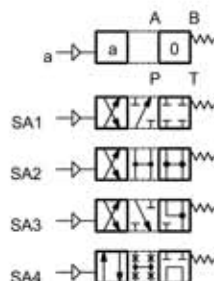

Type SB*:
1 operation side B
2 positions (central + external)
with spring centering

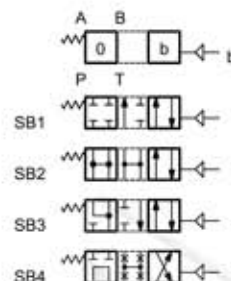

Type TA:
1 operation side A
2 external positions
with return spring

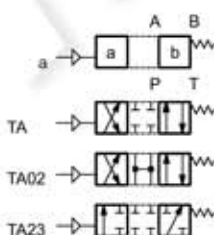

Type TB:
1 operation side B
2 external positions
with return spring

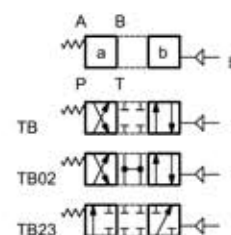

Type RK:
2 operations - 2 positions
with mechanical retention

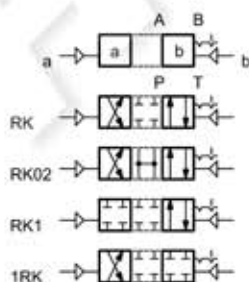

Besides the diagrams shown, which are the most frequently used, other special versions are available: consult our technical department for their identification and operating limits.

5 - PRESSURE DROPS Δp -Q

(values obtained with viscosity 36 cSt at 50 °C)

5.1 - DSA3

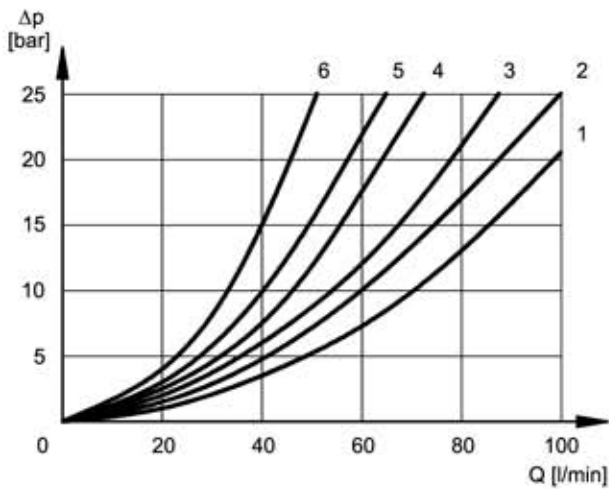

For pressure drops between A and B lines of spools S10, S20, S21, S22 and S23, which are used in the regenerative diagram, refer to curve 5.

PRESSURE DROPS WITH VALVE IN ENERGIZED POSITION

SPOOL TYPE	FLOW DIRECTION			
	P→A	P→B	A→T	B→T
	CURVES ON GRAPH			
S1, SA1, SB1	2	2	3	3
S2, SA2, SB2	1	1	3	3
S3, SA3, SB3	3	3	1	1
S4, SA4, SB4	5	5	5	5
S5	2	1	3	3
S6	2	2	3	1
S7, S8	4	5	5	5
S9	2	2	3	3
S10	1	3	1	3
S11	2	2	1	3
S12	2	2	3	3
S17	2	2	3	3
S18	1	2	3	3
S19	2	2	3	3
S20	1	5	2	
S21	5	1		2
S22	1	5	2	
S23	5	1		2
TA, TB	3	3	3	3
TA02, TB02	2	2	2	2
TA23, TB23	3	3		
RK	2	2	2	2
RK02	2	2	2	2
RK1, 1RK	2	2	2	2

PRESSURE DROPS WITH VALVE IN DE-ENERGIZED POSITION

SPOOL TYPE	FLOW DIRECTION				
	P→A	P→B	A→T	B→T	P→T
	CURVES ON GRAPH				
S2, SA2, SB2					2
S3, SA3, SB3			3	3	
S4, SA4, SB4					5
S5		4			
S6				3	
S7, S8			6	6	5
S10	3	3			
S11			3		
S18	4				
S22			3	3	
S23			3	3	

5.2 - DSA5

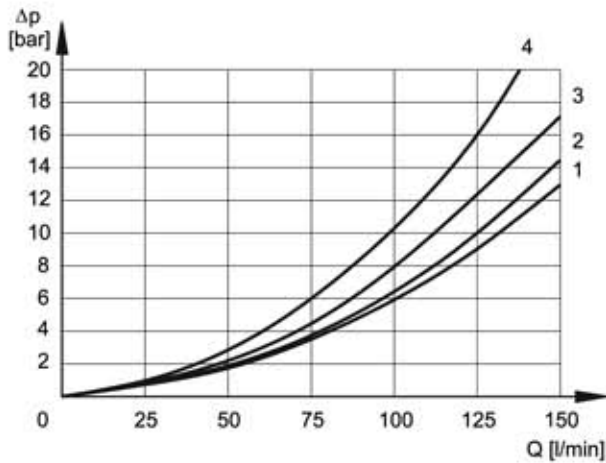

PRESSURE DROPS WITH VALVE IN ENERGIZED POSITION

SPOOL TYPE	FLOW DIRECTION			
	P→A	P→B	A→T	B→T
	CURVES ON GRAPH			
S1, SA1, SB1	2	2	1	1
S2, SA2, SB2	3	3	1	1
S3, SA3, SB3	3	3	2	2
S4, SA4, SB4	1	1	2	2
S5	2	1	1	1
S6, S11	3	3	2	2
S7, S8	1	1	2	2
S9	3	3	2	2
S10	1	1	1	1
S12	2	2	1	1
S17, S19	2	2	1	1
S18	1	2	1	1
S20, S21				
S22, S23				
TA, TB	3	3	2	2
TA02, TB02	3	3	2	2
TA23, TB23	4	4		
RK	3	3	2	2
RK02	3	3	2	2
RK1, 1RK	3	3	2	2

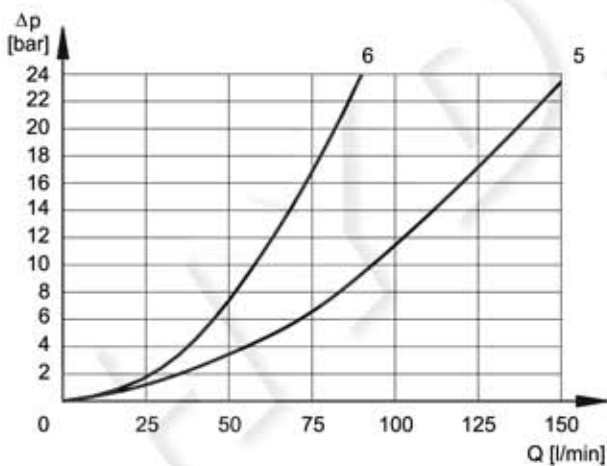

PRESSURE DROPS WITH VALVE IN DE-ENERGIZED POSITION

SPOOL TYPE	FLOW DIRECTION				
	P→A	P→B	A→T	B→T	P→T
	CURVES ON GRAPH				
S2, SA2, SB2					5
S3, SA3, SB3			6	6	
S4, SA4, SB4					5
S5		3			
S6				6	
S7					5
S10	3	3			
S11			6		
S18	3				
S22					
S23					

6 - OPERATING LIMITS

The curves define the flow rate operating fields according to the valve pressure of the different versions. The values have been obtained according to ISO 6403 norm, with mineral oil viscosity 36 cSt at 50 °C and filtration according to ISO 4406:1999 class 18/16/13.

6.1 - DSA3

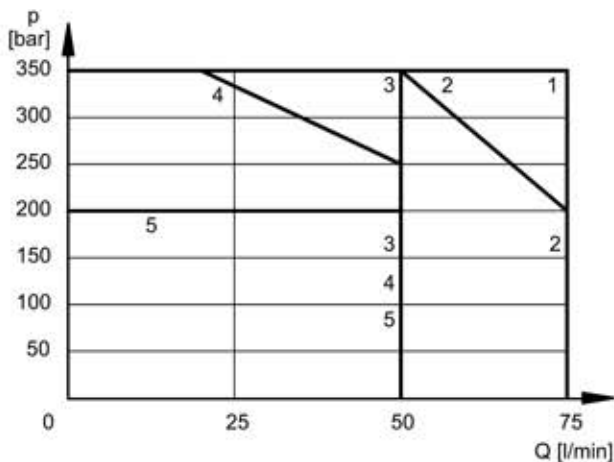

SPOOL TYPE	CURVE	
	P→A	P→B
S1,SA1,SB1	1	1
S2, SA2, SB2	1	1
S3, SA3, SB3	2	2
S4, SA4, SB4	3	3
S5	1	1
S6	3	2
S7	3	3
S8	3	3
S9	1	1
S10	1	1
S11	2	3
S12	1	1

SPOOL TYPE	CURVE	
	P→A	P→B
S17	1	1
S18	1	1
S19	1	1
S20	4	4
S21	4	4
S22	5	4
S23	4	5
TA, TB	1	1
TA02, TB02	1	1
TA23, TB23	1	1
RK	1	1
RK02	1	1
RK1, 1RK	1	1

6.2 - DSA5

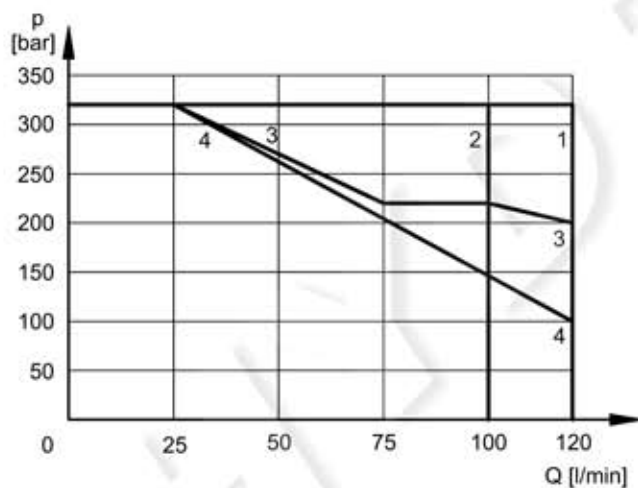

SPOOL TYPE	CURVE	
	P→A	P→B
S1,SA1,SB1	1	1
S2, SA2, SB2	1	1
S3, SA3, SB3	3 *	3 *
S4, SA4, SB4	4	4
S5		
S6		
S7		
S8		
S9		
S10		
S11		
S12		

SPOOL TYPE	CURVE	
	P→A	P→B
S17		
S18		
S19		
S20		
S21		
S22		
S23		
TA, TB	2 *	2 *
TA02, TB02		
TA23, TB23		
RK		
RK02		
RK1, 1RK		

* **NOTE:** for spools S3 and TA, the curve has been obtained with a min. piloting pressure of 4,5 bar. If the minimum piloting pressure used is 5,5 bar, refer to the curve n° 1 (320 bar - 120 l/min).

NOTE: The values indicated in the graphs are relevant to the standard valve. The operating limits can be considerably reduced if a 4-way valve is used with port A or B plugged or without flow.

7 - DSA3 OVERALL AND MOUNTING DIMENSIONS

DSA3 - S*
DSA3 - RK

dimensions in mm

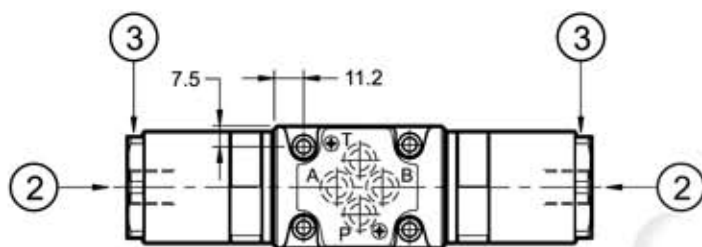
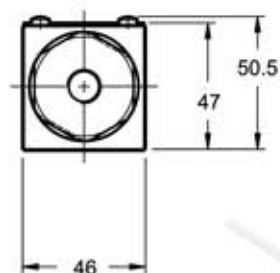
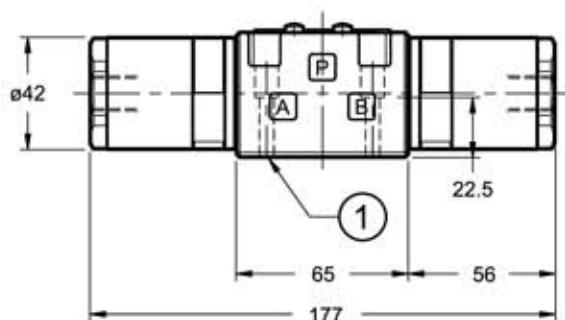

DSA3 - TA
DSA3 - SA*
DSA3 - TA23

operator position for configuration SB*, TB and TB23

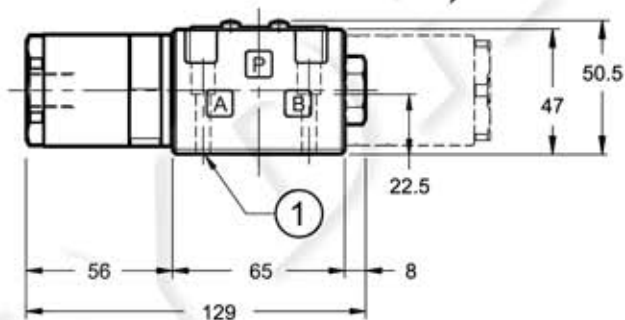

Valve fastening:	N. 4 SHC screws ISO 4762 - M5x30
Tightening torque:	5 Nm (bolts A 8.8)
Threads of mounting holes:	M5x10

1	Mounting surface with sealing rings: N. 4 OR type 2037 (9.25x1.78) 90 Shore
2	1/4" BSP connection for pneumatic actuation
3	Hexagon: spanner 38 Tightening torque 35 + 40 Nm

8 - DSA5 OVERALL AND MOUNTING DIMENSIONS

DSA5 - S*
DSA5 - RK

dimensions in mm

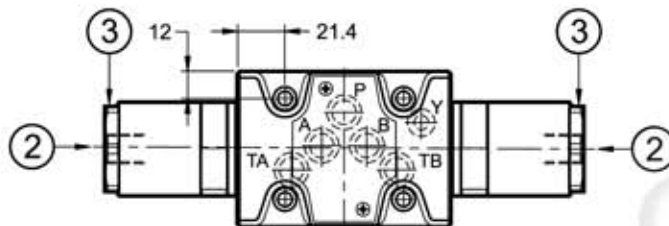
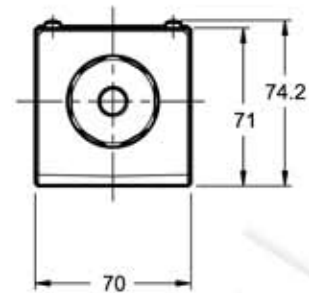
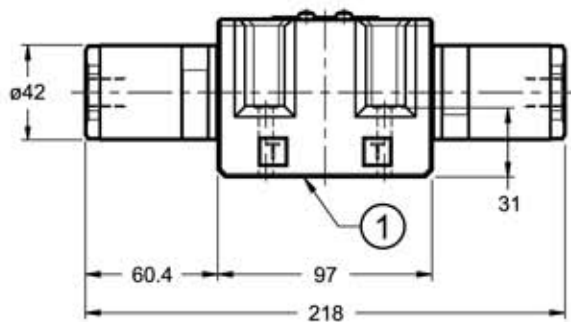

DSA5 - TA
DSA5 - SA*
DSA5 - TA23

operation position configuration SB*, TB and TB23

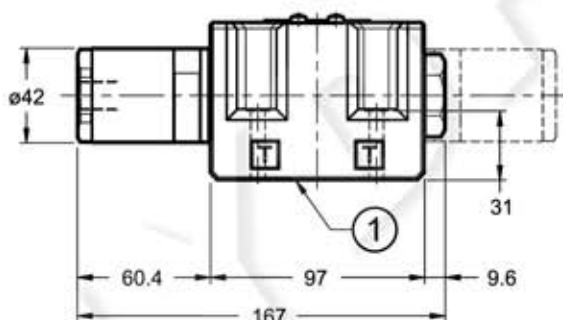

1	Mounting surface with sealing rings: N. 5 OR type 2050 (12.42x1.78) 90 Shore N. 1 OR type 2037 (9.25x1.78) 90 Shore
2	1/4" BSP connection for pneumatic operator
3	Hexagon: spanner 38 Tightening torque 35 + 40 Nm

Valve fastening:	N. 4 SHC screws ISO 4762 - M6x40
------------------	----------------------------------

Tightening torque:	8 Nm (bolts A 8.8)
--------------------	--------------------

Threads of mounting holes:	M6x10
----------------------------	-------

9 - INSTALLATION

Configurations with centering and return springs can be mounted in any position; type RK valves - without springs and with mechanical detent - must be mounted with the longitudinal axis horizontal.

Valve fixing is by means of screws or tie rods, with the valve mounted on a lapped surface, with values of planarity and smoothness that are equal to or better than those indicated in the drawing.

If the minimum values of planarity and/or smoothness are not met, fluid leakage between valve and mounting surface can easily occur.

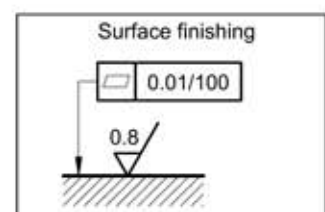

10 - SUBPLATES

(see catalogue 51 000)

	DSA3	DSA5
Type with rear ports	PMMD-AI3G	PMD4-AI4G - 3/4" BSP threaded
Type with side ports	PMMD-AL3G	PMD4-AL4G - 1/2" BSP threaded
Threading of ports P, T, A and B	3/8" BSP	



HYDROMA