

Part number:

093-10005a

HYDROMA

HYDRAULICKÉ SYSTÉMY

**HIDROMA
SISTEMS**

UKŁADY HYDRAULICZNE

HYDROMA

ГИДРАВЛИЧЕСКИЕ СИСТЕМЫ

41 150/110 ED



DS3 SOLENOID OPERATED DIRECTIONAL CONTROL VALVE

**SUBPLATE MOUNTING
ISO 4401-03 (CETOP 03)**

**p max 350 bar
Q max 100 l/min**

MOUNTING INTERFACE

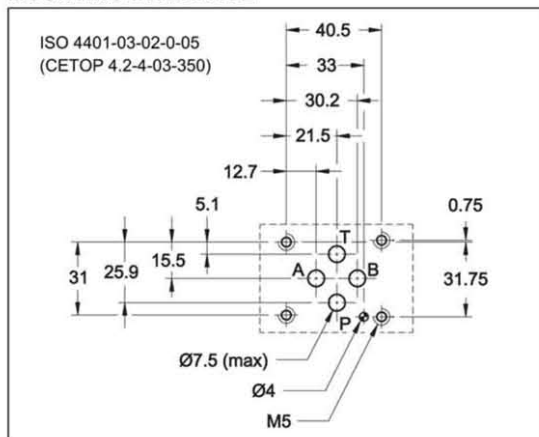

PERFORMANCES (obtained with mineral oil with viscosity of 36 cSt at 50°C)

Maximum operating pressure	bar	CC	CA	
		Ports P - A - B	350	
Port T		210	160	
Maximum flow rate	l/min	100	90	
Pressure drop $\Delta p-Q$	see paragraph 4			
Operating limits	see paragraph 6			
Electrical features	see paragraph 7			
Electrical connections	see paragraph 14			
Ambient temperature range	°C	-20 / +50		
Fluid temperature range	°C	-20 / +80		
Fluid viscosity range	cSt	10 + 400		
Recommended viscosity	cSt	25		
Fluid contamination degree	according to ISO 4406:1999 class 20/18/15			
Mass:	single solenoid valve	kg	1,5	1,35
	double solenoid valve	kg	2	1,8

OPERATING PRINCIPLE

- Direct acting, subplate mounting directional control valve, with mounting surface according to ISO 4401 (CETOP RP121H) standards.
- The valve body is made with high strength iron castings provided with wide internal passages in order to minimize the flow pressure drop. Wet armature solenoids with interchangeable coils are used (for further information on solenoids see par. 7).
- The valve is supplied with 3 or 4 ways designs, with 2 or 3 positions and with several interchangeable spools with different porting arrangements.
- The valve is available with DC or AC solenoids. DC solenoids can also be fed with AC power supply, by using connectors with a built-in rectifier bridge (see paragraph 7.2).
- The DC solenoids DS3 directional valve is also available with connection DUAL DIN 43650.
- The DC solenoids DS3 directional valve is also available in the versions with soft shifting (see par. 14) and with lever manual override.

Part number:

093-10005b

HYDROMA

HYDRAULICKÉ SYSTÉMY

**HIDROMA
SYSTEMS**

UKŁADY HYDRAULICZNE

HYDROMA

ГИДРАВЛИЧЕСКИЕ СИСТЕМЫ

DS3

1 - IDENTIFICATION CODE

	D	S	3	-		/	10	-		/	
--	----------	----------	----------	----------	--	----------	-----------	----------	--	----------	--

Solenoid operated directional control valve

ISO 4401-03 (CETOP 03) size

Spool type (see paragraph 3)

S*	RSA*	TA	RK
SA*	RSB*	TB	
SB*		TA*	
		TB*	

Series: _____
(the overall and mounting dimensions remain unchanged from 10 to 19)

Seals: _____
N = NBR seals for mineral oil (standard)
V = FPM seals for special fluids

DC power supply

D12 = 12 V
D24 = 24 V
D28 = 28 V
D48 = 48 V
D110 = 110 V
D220 = 220 V
D00 = valve without coils (see NOTE)

AC power supply

A24 = 24 V - 50 Hz
A48 = 48 V - 50 Hz
A110 = 110 V - 50 Hz / 120 V - 60 Hz
A230 = 230 V - 50 Hz / 240 V - 60 Hz
A00 = valve without coils (see NOTE)

F110 = 110 V - 60 Hz
F220 = 220 V - 60 Hz

Option: Surface treatment not standard. Omit if not required (see NOTE 2)

Manual override: omit for override integrated in the tube (standard)
CM = manual override, boot protected
CH = lever manual override (only for DC version)
CP = push manual override (only for DC version)
CPK = push manual override with mechanical retention (only for DC version)

Coil electrical connection:
K1 = plug for connector type DIN 43650 (standard)
K7 = plug for connector type DEUTSCH DT04-2P male (available on **D12** and **D24** coils only)
K12 = plug for M12 connector
K1 coils and **DUAL** DIN 43560 connector delivered together

NOTE 1: Coils locking ring and related OR are supplied together with valves.
NOTE 2: The valve is supplied with standard surface treatment of phosphating black. On request we can supply these valves with other surface finishes. Add suffix / **W** * at the end of the code.
W4 = carbonitriding with oxidation process. black colour
W5 = semi-gloss epoxy painting black RAL 9005 thickness 80 ÷ 100µ
W6 = gloss polyurethane painting black RAL 9005 thickness 140µ

NOTE: The locking rings of the coils and the relevant O-Rings are supplied together with valves

2 - HYDRAULIC FLUIDS

Use mineral oil-based hydraulic fluids HL or HM type, according to ISO 6743-4. For these fluids, use NBR seals (code N). For fluids HFDR type (phosphate esters) use FPM seals (code V). For the use of other fluid types such as HFA, HFB, HFC, please consult our technical department. Using fluids at temperatures higher than 80 °C causes a faster degradation of the fluid and of the seals characteristics. The fluid must be preserved in its physical and chemical characteristics.

DS3

3 - SPOOL TYPE

Type S*:
2 solenoids - 3 positions
with spring centering

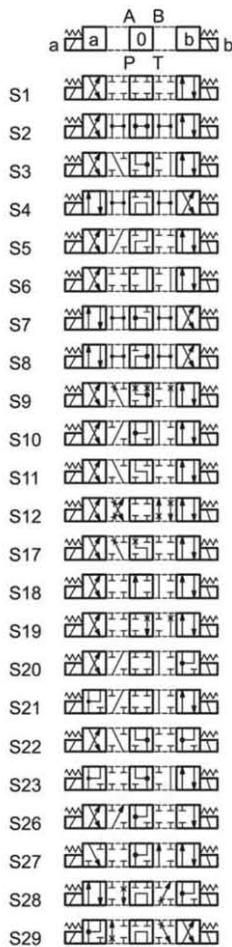

Type RK:
2 solenoids - 2 positions
with mechanical retention

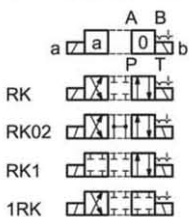

Type SA*:
1 solenoid side A
2 positions (central + external)
with spring centering

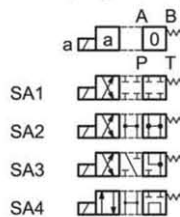

Type RSA*:
1 solenoid side A
2 positions (external + central)
with return spring

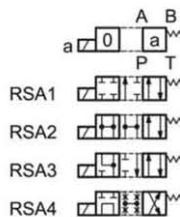

Type TA:
1 solenoid side A
2 external positions
with return spring

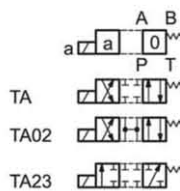

Type TA*:
1 solenoid side A
2 positions with return spring

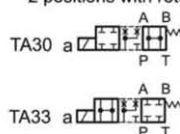

Type SB*:
1 solenoid side B
2 positions (central + external)
with spring centering

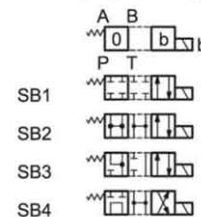

Type RSB*:
1 solenoid side B
2 positions (external + central)
with return spring

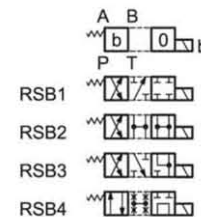

Type TB:
1 solenoid side B
2 external positions
with return spring

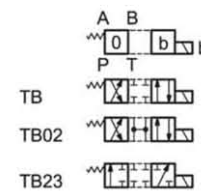

Type TB*:
1 solenoid side B
2 positions with return spring

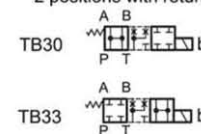

Besides the diagrams shown, which are the most frequently used, other special versions are available: consult our technical department for their identification, feasibility and operating limits.

Part number:

093-10005d

HYDROMA

HYDRAULICKÉ SYSTÉMY

**HIDROMA
SYSTEMS**

UKŁADY HYDRAULICZNE

HYDROMA

ГИДРАВЛИЧЕСКИЕ СИСТЕМЫ

DS3

4 - PRESSURE DROPS Δp -Q (obtained with viscosity 36 cSt at 50 °C)

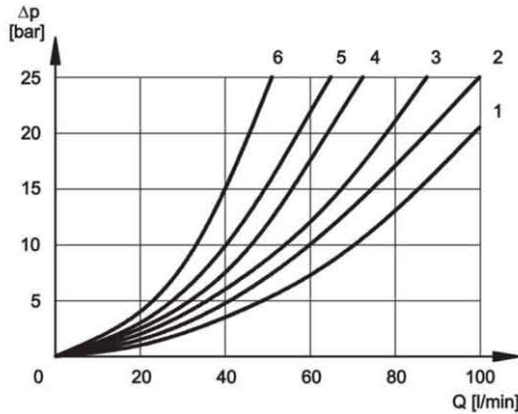

For pressure drops between A and B lines of spools S10, S20, S21, S22 and S23, which are used in the regenerative diagram, refer to curve 5.

PRESSURE DROPS WITH VALVE IN ENERGIZED POSITION

SPOOL TYPE	FLOW DIRECTION			
	P→A	P→B	A→T	B→T
	CURVES ON GRAPH			
S1, SA1, SB1	2	2	3	3
S2, SA2, SB2	1	1	3	3
S3, SA3, SB3, RSA3, RSB3	3	3	1	1
S4, SA4, SB4, RSA4, RSB4	6	6	6	6
S5	2	1	3	3
S6	2	2	3	1
S7, S8	6	6	6	6
S9	2	2	3	3
S10	1	3	1	3
S11	2	2	1	3
S12	2	2	3	3
S17	2	2	3	3
S18	1	2	3	3
S19	2	2	3	3
S20	1	5	2	
S21	5	1		2
S22	1	5	2	
S23	5	1		2
TA, TB	2	2	2	2
TA02, TB02	2	2	2	2
TA23, TB23	3	3		
RK	2	2	2	2
RK02	2	2	2	2
RK1, 1RK	2	2	2	2

PRESSURE DROPS WITH VALVE IN DE-ENERGIZED POSITION

SPOOL TYPE	FLOW DIRECTION				
	P→A	P→B	A→T	B→T	P→T
	CURVES ON GRAPH				
S2, SA2, SB2					2
S3, SA3, SB3, RSA3, RSB3			3	3	
S4, SA4, SB4, RSA4, RSB4					5
S5		4			
S6				3	
S7, S8					5
S10	3	3			
S11			3		
S18	4				
S22			3	3	
S23			3	3	

5 - SWITCHING TIMES

The values indicated are obtained according to ISO 6403 standard, with mineral oil viscosity 36 cSt at 50°C.

SPOOL TYPE	TIMES	
	ENERGIZING	DE-ENERGIZING
DC	25 ÷ 75 ms	15 ÷ 25 ms
AC	10 ÷ 25 ms	15 ÷ 40 ms

DS3

6 - OPERATING LIMITS

The curves define the flow rate operating fields according to the valve pressure of the different versions. The values have been obtained according to ISO 6403 norm with solenoids at rated temperature and supplied with voltage equal to 90% of the nominal voltage. The value have been obtained with mineral oil, viscosity 36 cSt, temperature 50 °C and filtration according to ISO 4406:1999 class 18/16/13.

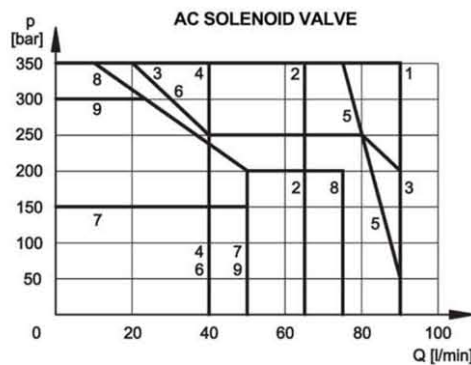
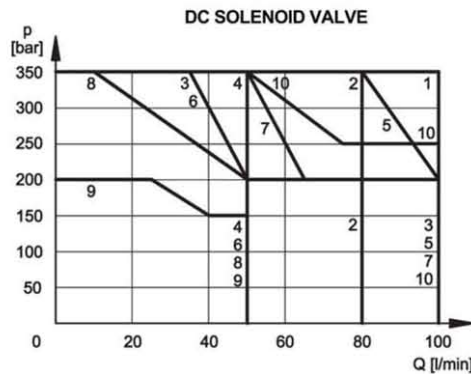

**AC SOLENOID VALVE with coil A110
fed with 110V - 60 Hz**

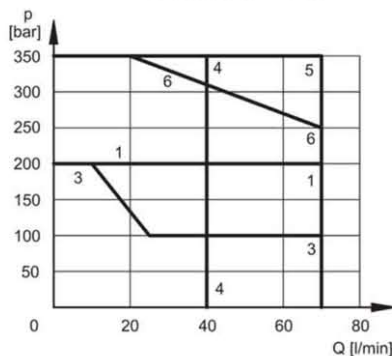

DC SOLENOID VALVE

SPOOL	CURVE	
	P→A	P→B
S1, SA1, SB1	1	1
S2, SA2, SB2	2	2
S3, SA3, SB3, RSA3, RSB3	3	3
S4, SA4, SB4, RSA4, RSB4	4	4
S5	1	1
S6	6	7
S7	4	4
S8	4	4
S9	10	10
S10	1	1
S11	7	6
S12	1	1
S17		
S18	1	1
S19		
S20	8*	8
S21	8	8*
S22	9*	8
S23	8	9*
TA, TB	5	5
TA02, TB02	1	1
TA23, TB23	2	2
RK	1	1
RK02	1	1
RK1, 1RK	1	1

AC SOLENOID VALVE

SPOOL	CURVE	
	P→A	P→B
S1, SA1, SB1	1	1
S2, SA2, SB2	2	2
S3, SA3, SB3, RSA3, RSB3	3	3
S4, SA4, SB4, RSA4, RSB4	4	4
S5	1	1
S6	3	4
S7	4	4
S8	4	4
S9	1	1
S10	1	1
S11	1	3
S12	1	1
S17		
S18	1	1
S19		
S20	9*	8
S21	8	9*
S22	7*	6
S23	6	7*
TA, TB	1	1
TA02, TB02	1	1
TA23, TB23	5	5
RK	1	1
RK02	1	1
RK1, 1RK	1	1

* Performance obtained for a valve with A and B lines connected the one to the piston-side chamber and the other to the rod-side chamber of a double-acting cylinder with area ratio 2:1.

SPOOL	CURVE	
	P→A	P→B
S1, SA1, SB1	1	1
S2, SA2, SB2	5	5
S3, SA3, SB3, RSA3, RSB3	3	3
S4, SA4, SB4, RSA4, RSB4	4	4

S9	1	1
TA, TB	5	5
RK	6	6

NOTE: The values indicated in the graphs are relevant to the standard solenoid valve. The operating limits can be considerably reduced if a 4-way valve is used with port A or B plugged.

For flow and pressure performances of soft-shifting configuration see paragraph 14. For DC solenoid valves fed with AC by means of connectors with built-in rectifier bridge, see paragraph 7.2

DS3

7 - ELECTRICAL FEATURES

7.1 Solenoids

These are essentially made up of two parts: tube and coil. The tube is threaded into the valve body and includes the armature that moves immersed in oil, without wear. The inner part, in contact with the oil in the return line, ensures heat dissipation.

The coil is fastened to the tube by a threaded ring, and can be rotated 360°, to suit the available space.

Protection from atmospheric agents CEI EN 60529

Plug-in type	IP 65	IP 67	IP 69 K
K2 AMP JUNIOR	x	x (*)	
K7 DEUTSCH DT04 male	x	x	x (*)
K12 DUAL DIN 43650	x	x (*)	

(*) The protection degree is guaranteed only with the connector correctly connected and installed

7.2 Current and absorbed power for DC solenoid valve

The table shows current and power consumption values relevant to the different coil types for DC.

The rectified current supply takes place by fitting the valve (with the exception of D12 coil) with an alternating current source (50 or 60 Hz), rectified by means of a bridge built-in to the "D" type connectors (see cat. 49 000), by considering a reduction of the operating limits (see diagram below).

Coils for direct current (values ±5%)

	Nominal voltage [V]	Resistance at 20°C [Ω]	Current consumpt. [A]	Power consumpt. [W]	Coil code	
					K1	K7
D12	12	4,4	2,72	32,6	1902860	1902940
D24	24	18,6	1,29	31	1902861	1902941
D28	28	26	1,11	31	1903082	
D48	48	78,6	0,61	29,3	1902863	
D110	110	423	0,26	28,6	1902864	
D220	220	1692	0,13	28,6	1902865	

Operating limits for DC solenoid valves fed with AC by means of connectors with built-in rectifier bridge.

SPOOL	CURVE	
	P→A	P→B
S1, SA1, SB1	1	1
S2, SA2, SB2	2	2
S3, SA3, SB3, RSA3, RSB3	3	3
S4, SA4, SB4, RSA4, RSB4	4	4
S9	6	6
TA, TB	5	5
RK	1	1

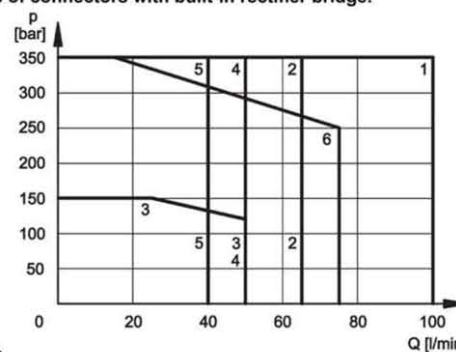

7.3 Current and absorbed power for AC solenoid valve

The table shows current and power consumption values at inrush and at holding, relevant to the different coil types for AC current.

Coils for alternating current (values ± 5%)

Suffix	Nominal Voltage [V]	Freq. [Hz]	Resistance at 20°C [Ω] (±1%)	Current consumption at inrush [A] (±5%)	Current consumption at holding [A] (±5%)	Power consumption at inrush (±5%) [VA]	Power consumption at holding (±5%) [VA]	Coil Code
A24	24	50	1,46	8	2	192	48	1902830
A48	48		5,84	4,4	1,1	204	51	1902831
A110	110V-50Hz 120V-60Hz	50/60	32	1,84	0,46	192	48	1902832
				1,56	0,39	188	47	
A230	230V-50Hz 240V-60Hz		140	0,76	0,19	176	44	1902833
				0,6	0,15	144	36	
F110	110	60	26	1,6	0,4	176	44	1902834
F220	220		106	0,8	0,2	180	45	1902835

Part number:

093-10005g

HYDROMA

HYDRAULICKÉ SYSTÉMY

**HIDROMA
SISTEMS**

UKŁADY HYDRAULICZNE

HYDROMA

ГИДРАВЛИЧЕСКИЕ СИСТЕМЫ

DS3

8 - OVERALL AND MOUNTING DIMENSIONS FOR DC SOLENOID VALVES

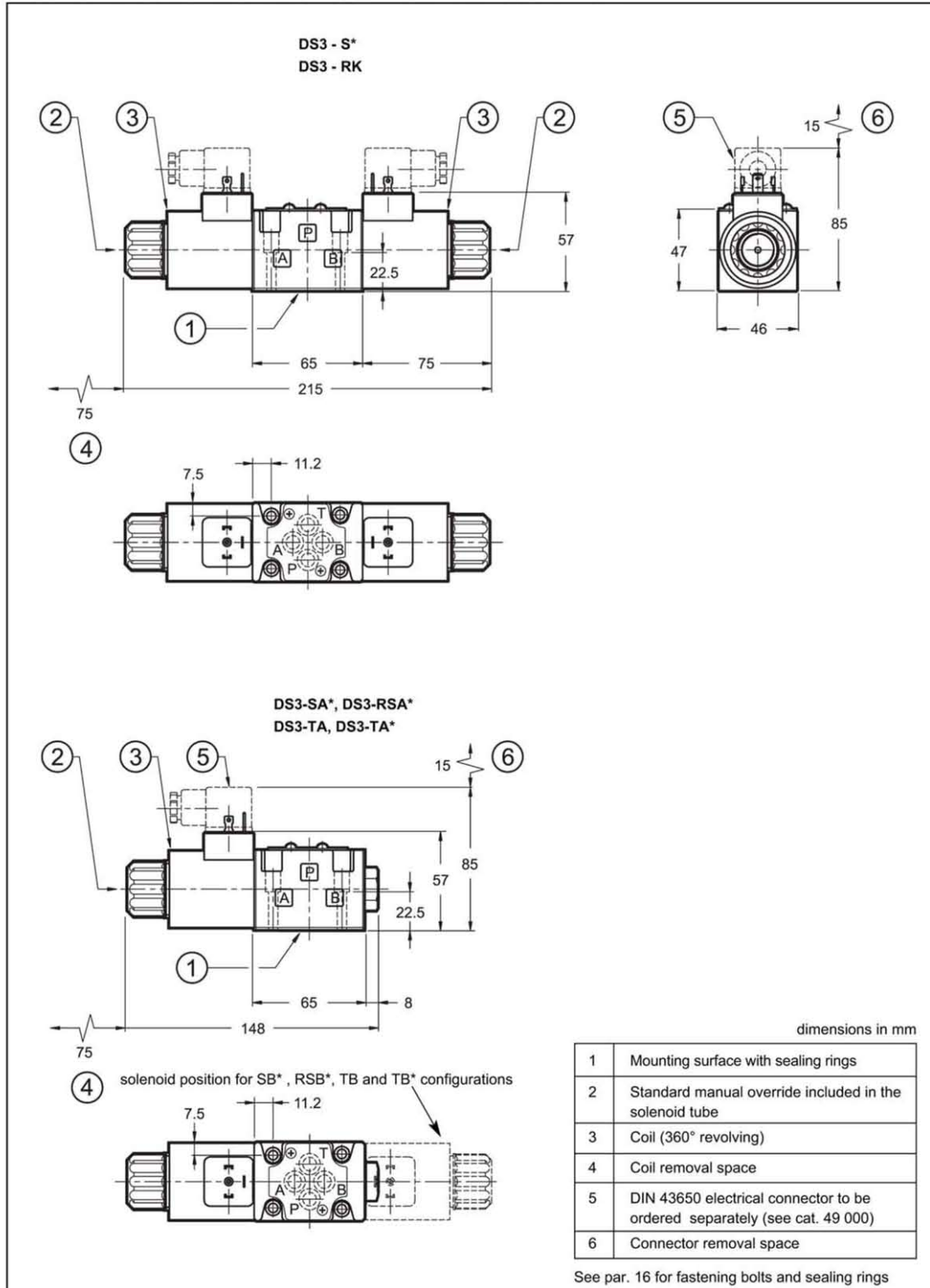

Part number:

093-10005h

HYDROMA

HYDRAULICKÉ SYSTÉMY

**HIDROMA
SYSTEMS**

UKŁADY HYDRAULICZNE

HYDROMA

ГИДРАВЛИЧЕСКИЕ СИСТЕМЫ

DS3

9 - OVERALL AND MOUNTING DIMENSIONS FOR AC SOLENOIDS VALVES

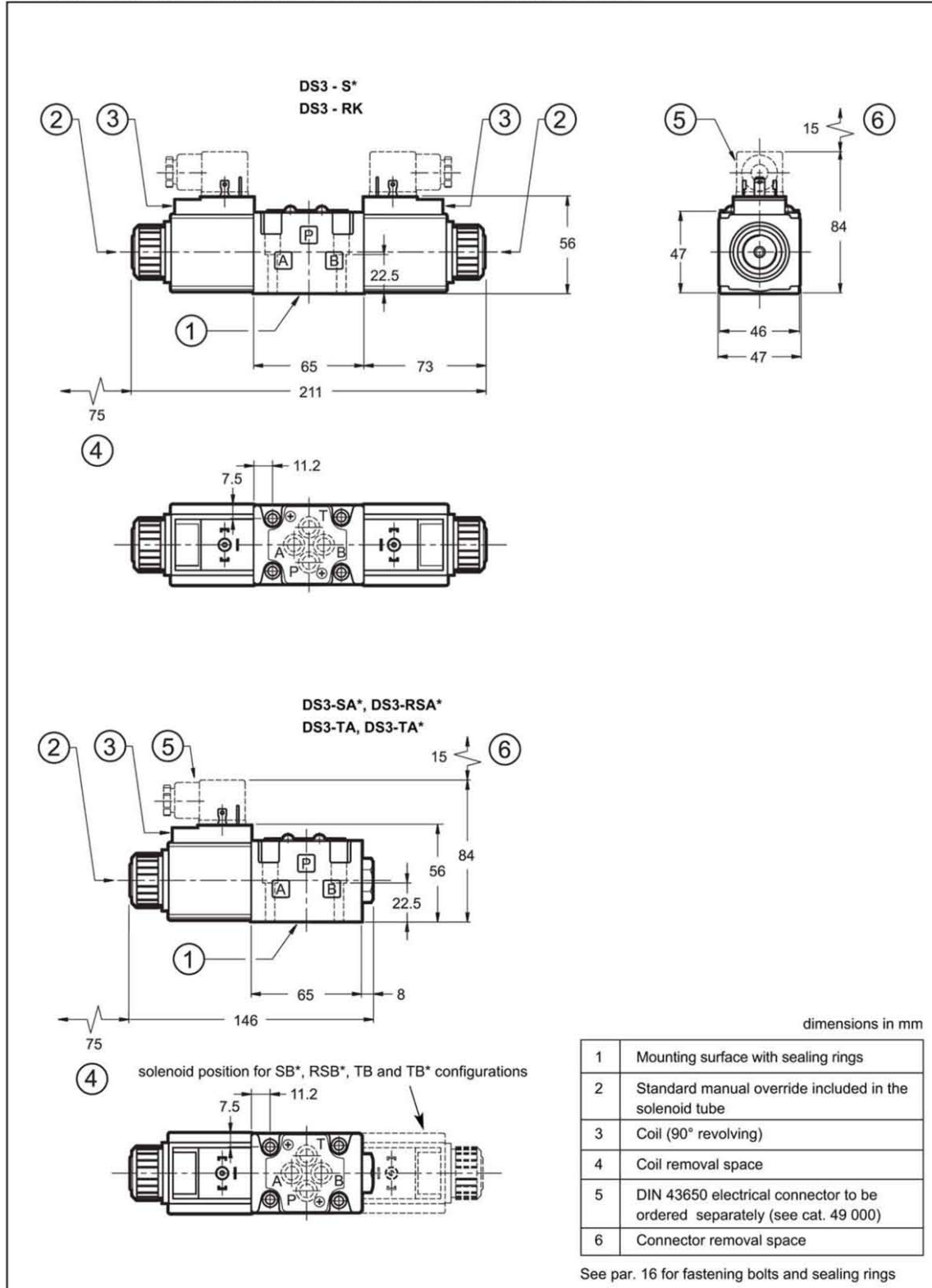

Part number:

093-10005i

HYDROMA

HYDRAULICKÉ SYSTÉMY

**HIDROMA
SYSTEMS**

UKŁADY HYDRAULICZNE

HYDROMA

ГИДРАВЛИЧЕСКИЕ СИСТЕМЫ

DS3

10 - INSTALLATION

Configurations with centering and return springs can be mounted in any position; type RK valves - without springs and with mechanical detent - must be mounted with the longitudinal axis horizontal. Valve fixing takes place by means of screws or tie rods, with the valve mounted on a lapped surface, with values of planarity and smoothness that are equal to or better than those indicated in the drawing. If the minimum values of planarity and/or smoothness are not met, fluid leakages between valve and mounting surface can easily occur.

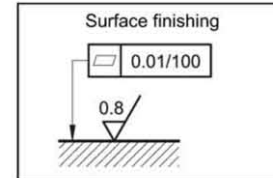

11 - ELECTRIC CONNECTIONS

connection for DIN 43650 connector type
code **K1 (standard)**

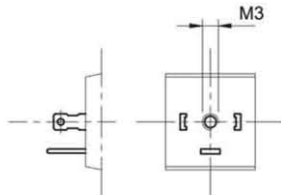

connection for DUAL DIN 43650
connector type
code **K12**

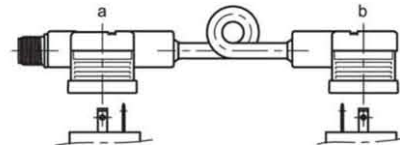

connection for DEUTSCH DT04-2P male
connector type
code **K7**

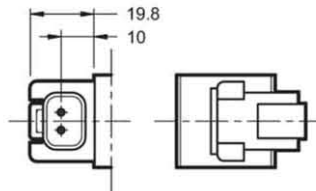

CONNECTOR M12x1 CONNECTION SCHEME

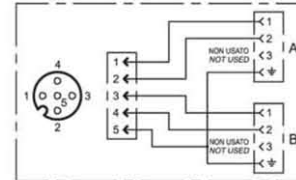

In K12 version the valve will be delivered together with the connector DUAL DIN 43650 with M12 connection already mounted on K1 coils. DUAL DIN connector allows you to power two solenoids with a single cable with socket M12.

12 - ELECTRIC CONNECTORS

The solenoid operated valves are delivered without connector, except the version K12, where the connector is delivered together with the valve. For coils with standard electrical connections K1 type (DIN 43650) the connectors can be ordered separately. For the identification of the connector type to be ordered please see cat. 49 000. For K2, K7 and K8 connection type the relative connectors are not available.

13 - MANUAL OVERRIDES

13.1 - Manual override, boot protected

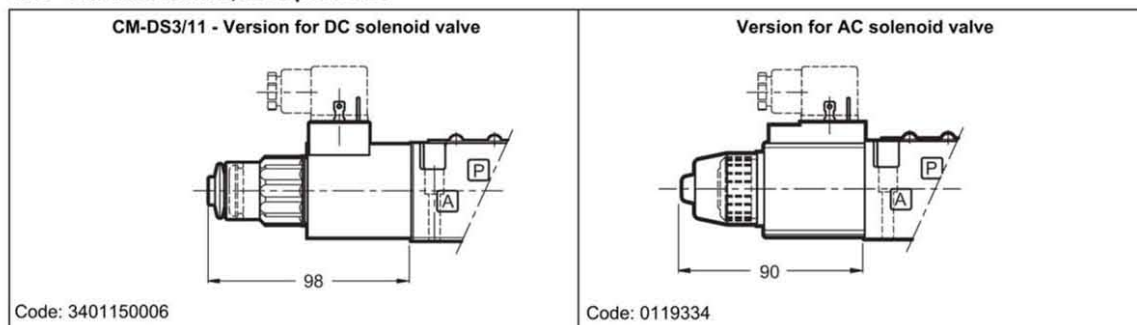

Part number:

093-10005j

HYDROMA

HYDRAULICKÉ SYSTÉMY

**HIDROMA
SYSTEMS**

UKŁADY HYDRAULICZNE

HYDROMA

ГИДРАВЛИЧЕСКИЕ СИСТЕМЫ

DS3

13.2 - CH-DS3/10 Lever manual override (only for DC solenoid valve)

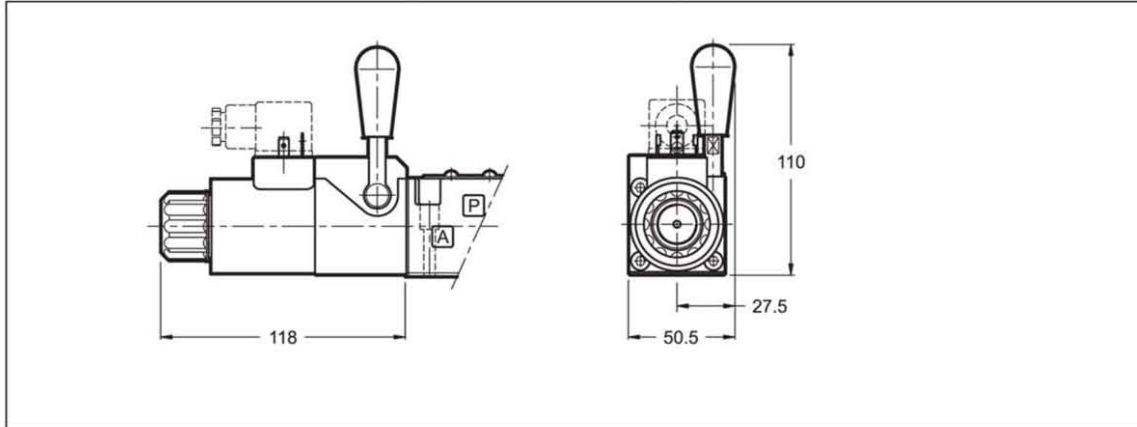

13.2 - CP-DS3/10 Push manual override (only for DC solenoid valve)

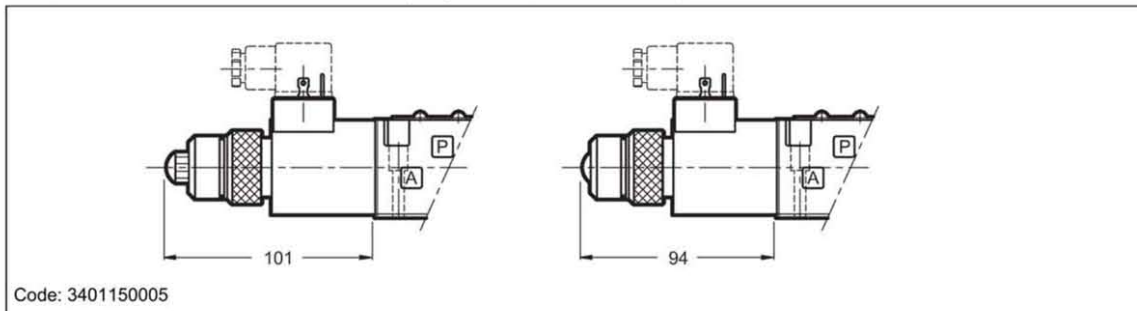

13.3 - CPK-DS3/10 Push manual override with mechanical retention (only for DC solenoid valve)

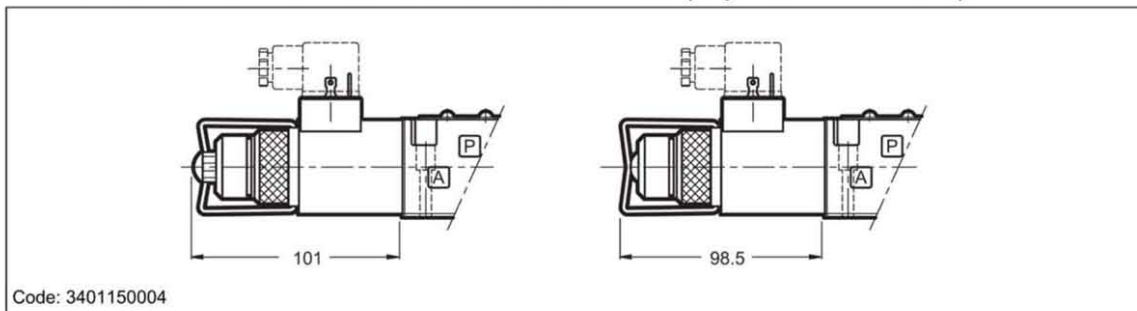

DS3

13 - SOFT-SHIFTING VERSIONS FOR DC SOLENOID VALVE

Identification code

D	S	3	-	/	12	-	/	F	
----------	----------	----------	---	---	-----------	---	---	----------	--

Solenoid operated directional control valve

ISO 4401-03 (CETOP 03) size

Spool type

S1	TA12
S2F	TB12
S4	TA23
S9	TB23
S12	

Series: _____
(the overall and mounting dimensions remain unchanged from 10 to 19)

Seals: _____
N = NBR seals for mineral oil (**standard**)
V = FPM seals for special fluids

NOTE :The valve is supplied with standard surface treatment of phosphating black. On request we can supply these valves with other surface finishes. Add suffix **/W*** at the end of the code.

W4 = carbonitriding with oxidation process.black colour
W5 = semi-gloss epoxy painting black RAL 9005
thickness 80 ± 100µ
W6 = gloss polyurethane painting black RAL 9005
thickness 140µ

Option: non-standard surface treatment. Omit if not required (see **NOTE**)

Manual override (see par.1)

Soft-shifting

Coil electrical connection: (see paragraph 11)
K1 = plug for connector type DIN 43650 (**standard**)
K7 = plug for connector type DEUTSCH DT04-2P male (available on **D12** and **D24** coils only)
K12 = plug for M12 connector K1 coils and DUAL DIN 43560 connector delivered together

Coil type
D12 = 12 V
D24 = 24 V
D28 = 28 V
D110 = 110 V
D220 = 220 V

This version enables hydraulic actuators to perform a smooth start and stop by reducing the speed of movement of the valve spool.

The diagram on the side shows the operating limits of the spools available in the soft-shifting version (**NOTE**: for this version, the S9 spool must be used instead of the S3 one).

The table on the side shows the switching times. The values indicated are obtained according to ISO 6403 standard, with mineral oil viscosity 36 cSt at 50°C.

The shifting time and characteristics curves, are influenced by the viscosity (and thus by the temperature) of the operating fluid. Moreover, times can vary according to the flow rate and operating pressure values of the valve.

For the correct functioning of the soft-shifting, ensure that the solenoid tubes are always filled with oil. For this purpose, we recommend to install a backpressure valve set at 1 ± 2 bar on T line.

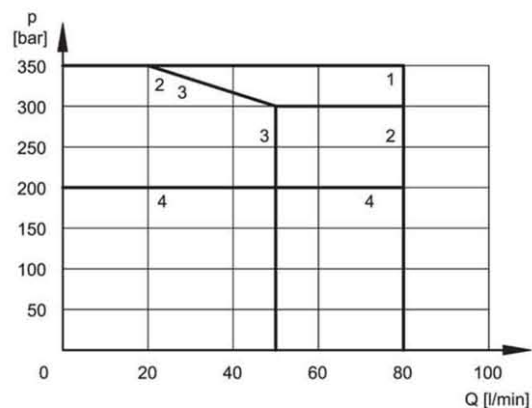

SPOOL	CURVE		TIMES [ms]	
	P-A	P-B	ENERGIZING	DE-ENERGIZING
S1, S12	1	1	350	200 ± 300
S2F	3	3	400	100 ± 250
S4	3	3	350	150 ± 300
S9	2	2	400	200 ± 300
TA23, TB23	4	4	300	200 ± 300

Part number:

093-100051

HYDROMA

HYDRAULICKÉ SYSTÉMY

**HIDROMA
SISTEMS**

UKŁADY HYDRAULICZNE

HYDROMA

ГИДРАВЛИЧЕСКИЕ СИСТЕМЫ

DS3

15 - SPARE PARTS FOR DC SOLENOID VALVE

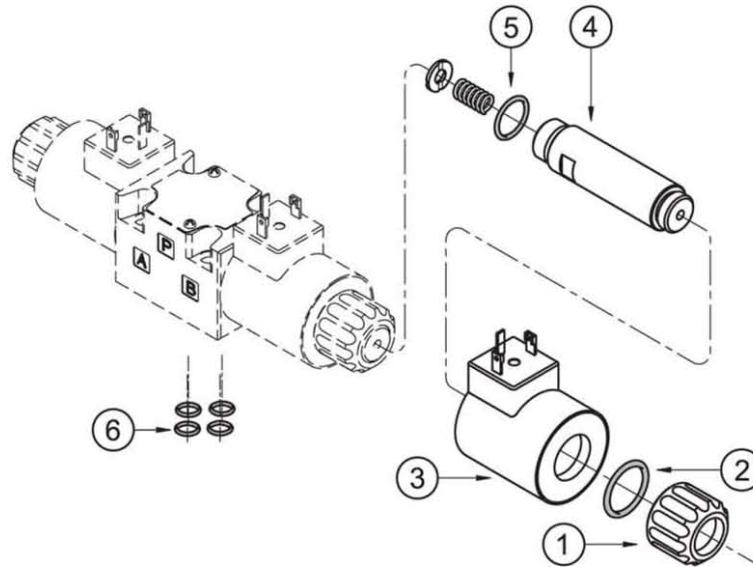

**DC COILS AND ELECTRICAL CONNECTORS
IDENTIFICATION CODE**

C 22S3 - / 11

Supply voltage

D12 = 12 V
D24 = 24 V
D28 = 28 V
D48 = 48 V
D110 = 110 V
D220 = 220 V

Series no.:
(the overall and
mounting dimensions
remain unchanged from
10 to 19)

Coil electrical connection:
K1 = plug for connector type
DIN 43650 (**standard**)
K7 = plug for connector type
DEUTSCH DT04-2P male
(available on D12 and D24
coils only)
K12 = K1 coils + DUAL DIN
43560 connector

1	Coil locking ring with seal included cod. 0119412
2	ORM type 0220-20 (22x2) - 70 Shore
3	Coil (see identification code)
4	Solenoid tube for standard version: TD22-DS3/10N (NBR seals) TD22-DS3/10V (FPM seals) Solenoid tube for version with soft-shifting: TD22-DS3F/10N (NBR seals) TD22-DS3F/10V (FPM seals) NOTE: OR n°5 included
5	OR type 2062 (15.6x1.78) - 70 Shore
6	N. 4 OR type 2037 (9.25x1.78) - 90 Shore

SEALS KIT

The codes include the O-Ring n° 2, 5 and 6.
Cod. 1985406 NBR seals
Cod. 1985410 FPM (viton) seals

NOTE: the spare part of the connector K12 (DUAL DIN) may
be ordered with code 0672136

Part number:

093-10005m

HYDROMA

HYDRAULICKÉ SYSTÉMY

**HIDROMA
SISTEMS**

UKŁADY HYDRAULICZNE

HYDROMA

ГИДРАВЛИЧЕСКИЕ СИСТЕМЫ

DS3

16 - SPARE PARTS FOR AC SOLENOID VALVE

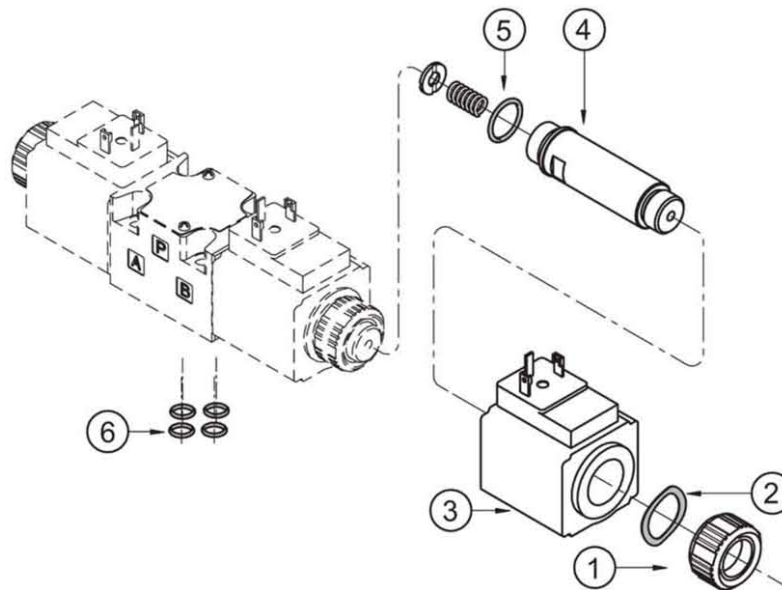

AC COILS IDENTIFICATION CODE

C 20.6S3 - / 10

Supply voltage

A24 = 24 V - 50 Hz
A48 = 48 V - 50 Hz
A110 = 110 V - 50 Hz
 120 V - 60 Hz
A230 = 230 V - 50 Hz
 240 V - 60 Hz
F110 = 110 V - 60 Hz
F220 = 220 V - 60 Hz

Series no.:
 (the overall and mounting dimensions remain unchanged from 10 to 19)

K1 = Plug for connector type DIN 43650 (standard)
K12 = K1 coils + DUAL DIN 43560 connector

1	Coil locking ring cod. 0119333
2	Snap ring cod. 0550483
3	Coil (see identification code on the side)
4	Solenoid tube : TA20.6-DS3/10N (NBR seals) TA20.6-DS3/10V (FPM seals) NOTE: OR n° 5 included
5	OR type 2062 (15.6x1.78) - 70 Shore
6	N. 4 OR type 2037 (9.25x1.78) - 90 Shore

SEALS KIT

The codes include the OR nr. 5 and 6.

Cod. 1985406 NBR seals
Cod. 1985410 FPM (viton) seals

NOTE: the spare part of the connector K12 (DUAL DIN) may be ordered with code 0672136

17 - VALVE FASTENING BOLTS

4 fastening bolts M5x30 (12.9 class recommended)
 Tightening torque 5 Nm (bolts A 8.8) - 8 Nm (bolts A 12.9)

18 - SUBPLATES (See catalogue 51 000)

Type PMMD-AI3G with rear ports 3/8" BSP
Type PMMD-AL3G with side ports 3/8" BSP